



OXYGEN

EXECUTIVE

OXYGEN ES UNA GAMA DIRECCIONAL ÁMPLIA, CON UN AÑADIDO DE DISEÑO Y ACABADOS EXCLUSIVOS DE GRAN CALIDAD QUE OFRECE LA POSIBILIDAD DE CREAR ESPACIOS ÚNICOS CUIDANDO AL MÁXIMO LOS DETALLES.

OXYGEN IS A DIRECTIONAL RANGE, WITH AND ADDED VALUE IN DESIGN AND EXCLUSIVE FINISHES OF GREAT QUALITY, THAT OFFERS THE POSSIBILITY OF CREATING UNIQUE SPACES TAKING CARE OF ALL THE DETAILS.

OXYGEN EST UNE GAMME DIRECTIONNELLE, AVEC UN PLUS EN DESIGN ET DES FINITIONS EXCLUSIVES DE GRANDE QUALITÉ, QUI OFFRE LA POSSIBILITÉ DE CRÉER DES ESPACES UNIQUES EN PRENANT SOIN DES DÉTAILS.

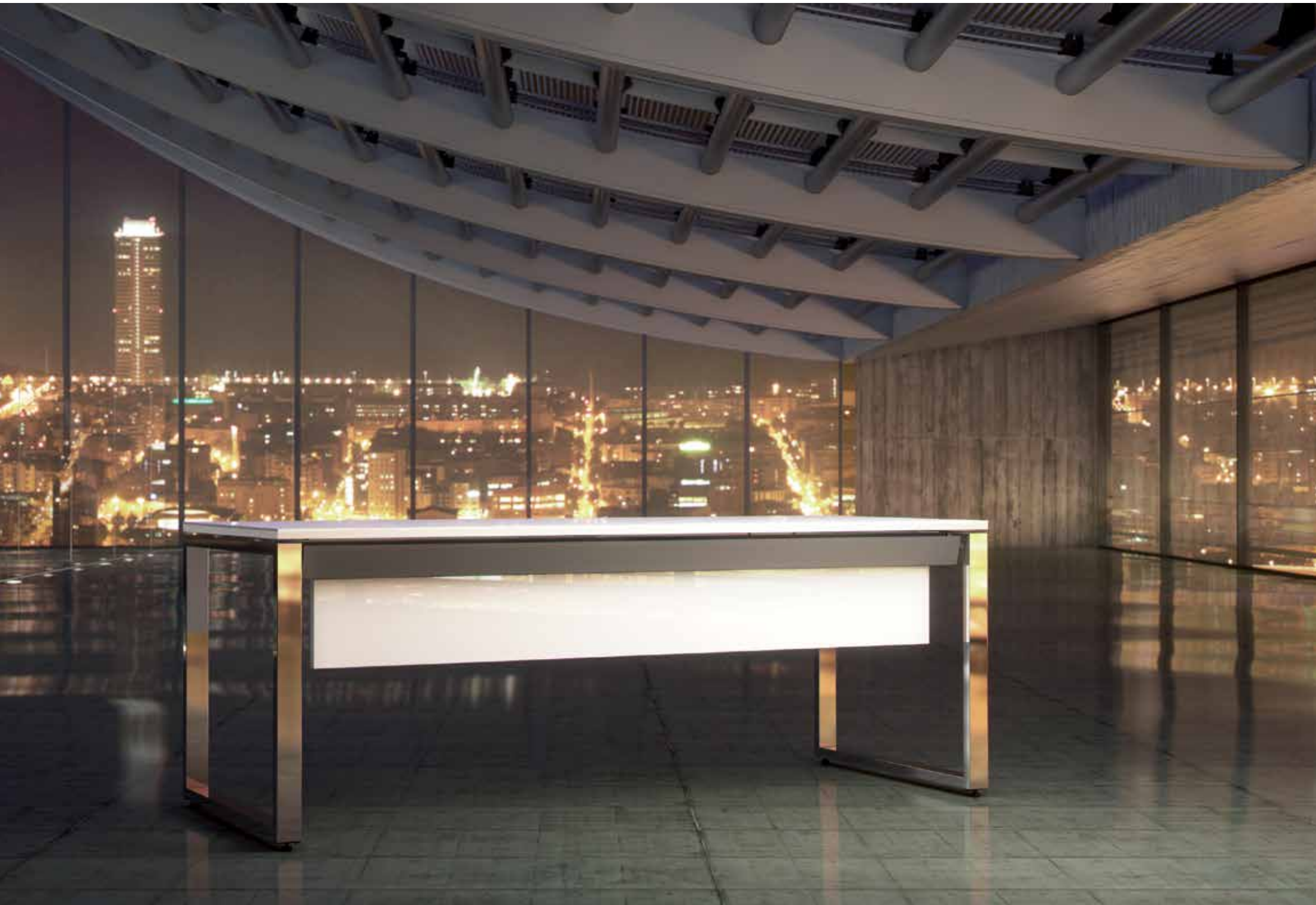

DESIGN: (LUXE) BLANCO / WHITE / BLANC.



DESIGN: (LUXE) BLANCO / WHITE / BLANC.





DESIGN: (LUXE) CUZCO - ORO.



DESIGN: (LUXE) CUZCO - ORO.





DESIGN: (CRISTAL / VIDRE / GLASS / VERRE) NEGRO, BLACK, NOIR. (LUXE) BLANCO, WHITE, BLANC.



DESIGN: (LUXE) BLANCO, WHITE, BLANC. (LUXE) ANTRACITA, GRAPHITE, ANTHRACITE.

LA COMBINACIÓN DEL CRISTAL CON LAS ESTRUCTURAS CROMADAS BRINDAN UNA IMÁGEN EXCLUSIVA Y DE ALTA CÁLIDAD.
 COMBINING GLASS DESKTOPS WITH CHROMED STRUCTURES, PROVIDES AN EXCLUSIVE AND HIGH QUALITY RESULT.
 LA COMBINAISON DE BUREAUX EN VERRE ET DE STRUCTURES CHROMÉES DONNE UN RÉSULTAT EXCLUSIF ET DE GRANDE QUALITÉ.





DESIGN: (LUXE) ANTRACITA METALDECO / ANTHRACITE METALDECO.



DESIGN:(LUXE) NEGRO / BLACK / NOIR.

LÍNEAS FLUIDAS Y LIGERAS, SENSACIONES TÁCTILES Y VISUALES.
UN BALANCE PERFECTO ENTRE PERCEPCIÓN, FORMA Y FUNCIONALIDAD.

FLUID AND LIGHT LINES, TACTILE AND VISUAL SENSATIONS. A PERFECT
BALANCE BETWEEN PERCEPTION, SHAPE AND FUNCTIONALITY.

DES LIGNES FLUIDES ET LÉGÈRES, DES SENSATIONS TACTILES
ET VISUELLES. UN ÉQUILIBRE PARFAIT ENTRE PERCEPTION, FORME ET
FONCTIONNALITÉ.



DESIGN: (LUXE) BLANCO / WHITE / BLANC. (LUXE) NEGRO / BLACK / NOIR.



DESIGN: (LUXE) BLANCO / WHITE / BLANC. (LUXE) NEGRO / BLACK / NOIR.



DESIGN: (LUXE) BLANCO / WHITE / BLANC.

POSIBILIDAD DE INTEGRAR UNA SOFISTICADA BANDEJA PASACABLES HORIZONTAL DE GRAN CAPACIDAD Y DE SENCILLA INSTALACIÓN COMO ELEMENTO DE ELECTRIFICACIÓN QUE FACILITA LA GESTIÓN DEL CABLEADO.

POSSIBILITY OF INTEGRATING A SOPHISTICATED HORIZONTAL CABLE TRAY OF GREAT CAPACITY AND EASY TO ASSEMBLE AS ELEMENT OF ELECTRIFICATION THAT FACILITATES THE WIRING MANAGEMENT SYSTEM.

POSSIBILITÉ D'INTÉGRER UNE GOULOTTE PASACABLES HORIZONTALE D'UNE GRANDE CAPACITÉ ET D'INSTALLATION SIMPLE COMME L'ÉLÉMENT D'ÉLECTRIFICATION QUI FACILITE LA GESTION DU CÂBLAGE.



ELEVANDO EL VALOR ERGONÓMICO. UNA SOLUCIÓN CONTEMPORÁNEA TECNOLÓGICAMENTE AVANZADA QUE OFRECE UN ALTO NIVEL DE FUNCIONALIDAD Y ESTILISMO.

RAISING THE ERGONOMIC VALUE, A TECHNOLOGICALLY ADVANCED CONTEMPORARY SOLUTION THAT OFFERS A HIGH LEVEL OF FUNCTIONALITY AND FASHION DESIGN.

EN ÉLEVANT LA VALEUR ERGONOMIQUE. UNE SOLUTION CONTEMPORAINE TECHNOLOGIQUEMENT AVANCÉE QUI OFFRE UN HAUT NIVEAU DE FONCTIONNALITÉ ET DE STYLISME.





NUEVA GENERACIÓN DE ACCESORIOS DEDICADA AL ENTORNO DE OFICINA DIRECCIONAL QUE FACILITA EL ACCESO A LA ELECTRIFICACIÓN Y DATOS.

NEW GENERATION OF COMPLEMENTS DEDICATED TO THE EXECUTIVE ENVIRONMENT THAT FACILITATES THE ELECTRIFICATION AND INFORMATION.

NOUVELLE GÉNÉRATION D'ACCESSOIRES DÉDIÉE À L'ENVIRONNEMENT DE BUREAU DIRECTIONNEL QUI FACILITE L'ACCÈS À L'ÉLECTRIFICATION ET AUX DONNÉES

DISEÑO, EFICACIA Y BIENESTAR EN EL PUESTO DE TRABAJO. ATRACTIVA CREDENZA MULTIFUNCIONAL CON GAMA DE COMPLEMENTOS QUE LE AYUDAN A ORGANIZAR SU ESPACIO.

DESING, EFFICIENCY AND WELLBEING IN THE WORKING PLACE. ATTRACTIVE MULTIFUNCTIONAL CREDENZA WITH RANGE OF COMPLEMENTS THAT HELP TO ORGANIZE YOUR SPACE.

DESSIN, EFFICACITÉ ET BIEN-ÊTRE DANS LE POSTE DE TRAVAIL. CREDENZA ATTRACTIVE ET MULTIFONCTIONNELLE AVEC GAMME DE COMPLÉMENTS QUI L'AIDENT À ORGANISER SON ESPACE.



PUERTAS CON SISTEMA DE CIERRE AMORTIGUADO. / SOFT CLOSING SYSTEM, BRAKE SYSTEM FOR THE DOOR CLOSURE IS AMORTIZED. / FERMETURE DES PORTES SOFT CLOSING, AVEC SYSTÈME DE FREIN POUR LA PORTE DE FERMETURE QUI EST AMORTIE.

CERRADURA CON FALLEBA PLANA LINEAL QUE EVITA LA VIBRACIÓN DE LA PUERTA. DISEÑO NOVEDOSO. / LINEAR FLAT DOOR BAR THAT PREVENTS VIBRATION OF DOOR. NEW DESIGN. / CRÉMONE LINÉAIRE PLAT QUI ÉVITE LA VIBRATION DE LA PORTE. CONCEPTION ORIGINALE.

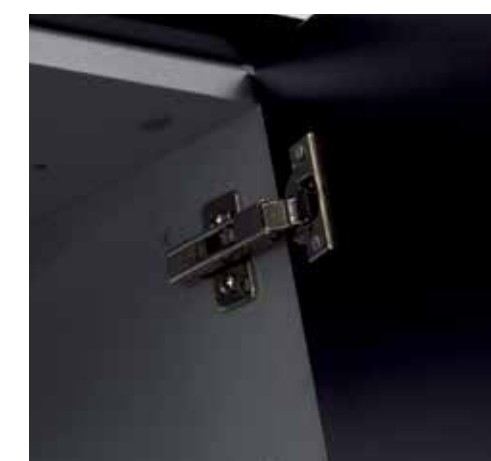

MONTAJE MESA /DESK ASSEMBLY / ASSEMBLAGE DU BUREAU.

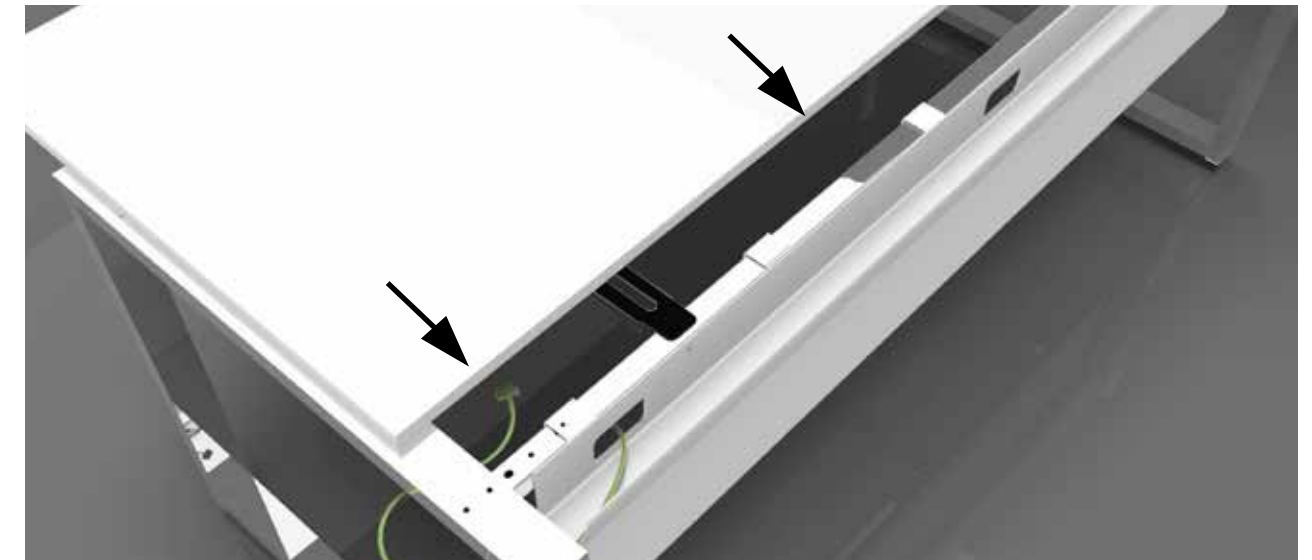

ACABADOS / FINISHES / FINITIONS.



ESTRUCTURA
STRUCTURE
STRUCTURE

BLANC
WHITE
BLANC



ESTRUCTURA
STRUCTURAL
STRUCTURE

CROM
CHROME
CHROME

MESA RECTANGULAR.
RECTANGULAR DESK.
BUREAUX RECTANGULAIRE.

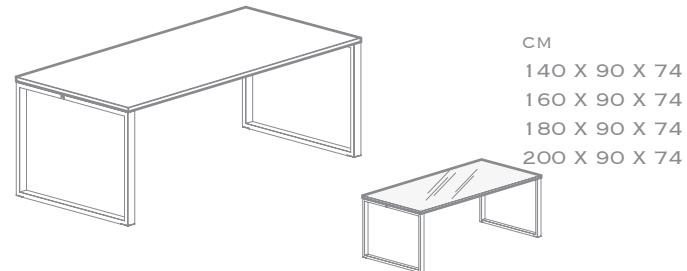

CM
140 X 90 X 74
160 X 90 X 74
180 X 90 X 74
200 X 90 X 74

FORRO LATERAL PARA ESTRUCTURA.
DECORATIVE PANEL FOR STRUCTURE.
LATÉRAL DÉCORATIF POUR STRUCTURE.

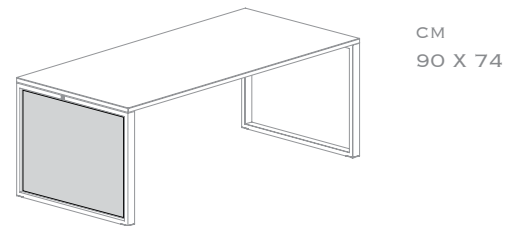

CM
90 X 74

ALA PARA MESA.
RETURN DESK.
RETOUR ACCROCHÉS.

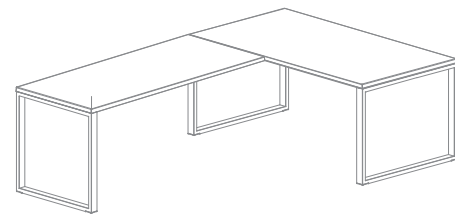

CM
95 X 60 X 74
95 X 60 X 74

MESA RECTANGULAR PARA CREDENZA.
DESK FOR CREDENZA.
BUREAUX POUR CRÉDENCE.

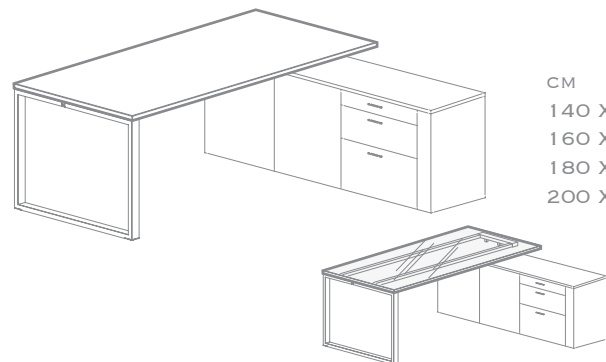

CM
140 X 90 X 74
160 X 90 X 74
180 X 90 X 74
200 X 90 X 74

MESA DE JUNTAS RECTANGULAR.
RECTANGULAR MEETING TABLE.
TABLE DE RÉUNION RECTANGULAIRE.

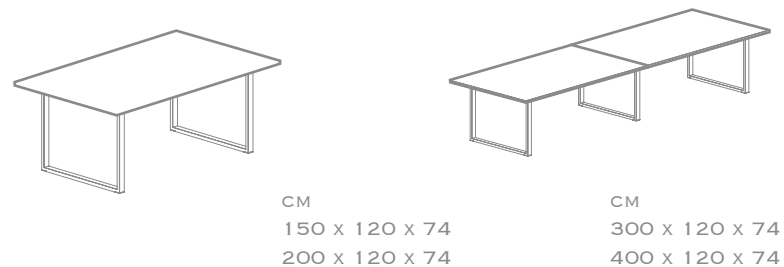

CM
150 x 120 x 74
200 x 120 x 74

CM
300 x 120 x 74
400 x 120 x 74

MESA DE JUNTAS CIRCULAR CON PATA CÁLIZ.
CIRCULAR MEETING TABLE WITH METALLIC LEG.
TABLE DE RÉUNION CIRCULAIRE PIED EN FONTE.

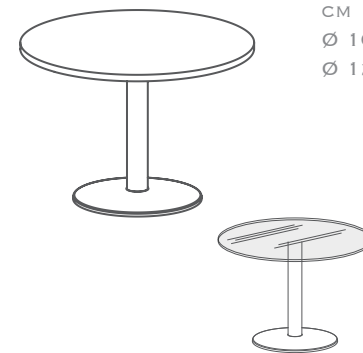

CM
Ø 100 x 74
Ø 120 x 74

FALDONES.
MODESTY PANELS.
VOILES DE FOND.

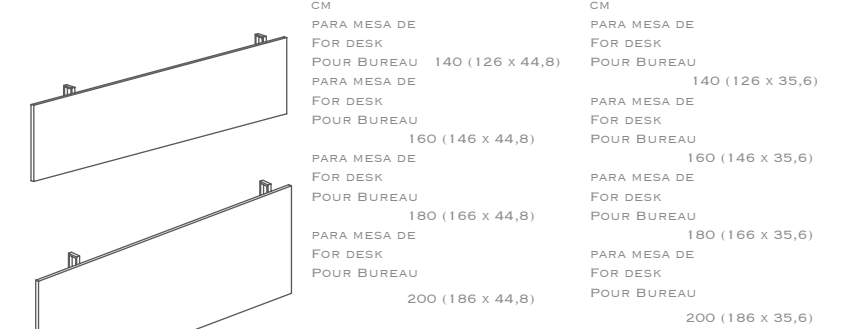

CM
PARA MESA DE
FOR DESK
POUR BUREAU 140 (126 x 44,8)
PARA MESA DE
FOR DESK
POUR BUREAU 160 (146 x 44,8)
PARA MESA DE
FOR DESK
POUR BUREAU 180 (166 x 44,8)
PARA MESA DE
FOR DESK
POUR BUREAU 200 (186 x 44,8)

CM
PARA MESA DE
FOR DESK
POUR BUREAU 140 (126 x 35,6)
PARA MESA DE
FOR DESK
POUR BUREAU 160 (146 x 35,6)
PARA MESA DE
FOR DESK
POUR BUREAU 180 (166 x 35,6)
PARA MESA DE
FOR DESK
POUR BUREAU 200 (186 x 35,6)

BANDEJA PASACABLES HORIZONTAL.
HORIZONTAL CABLE TRAY.
GOULOTTE HORIZONTALE.

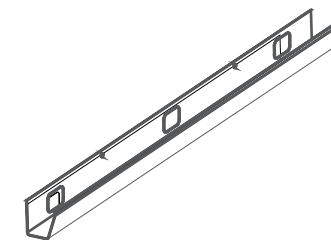

CM
140
160
180
200

PASACABLES VERTICAL.
VERTICAL CABLE HOLDER.
PASSE CABLES VERTICAL.



CM
L8,0 x W55,8 x H3,0

PASACABLES VERTICAL TUBULAR.
VERTICAL CABLE COLLECTOR.
ACCESSOIRE VERTICAL POUR DESCENTE
DE CABLES.



CM
Ø 60

PASACABLES CON CEPILLO.
COVER WITH BRUSH GUARD.
PASSE CABLES AVEC BROSSE.



CM
L32 x W11 x H1,3

POWER BOX.
POWER BOX.
POWER BOX.

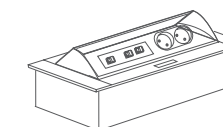

CM
L26,6 x W13,5 x H6,8

POWER BOX.
POWER BOX.
POWER BOX.

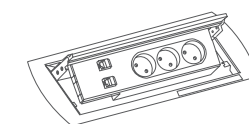

CM
L35,86 x W17 x H7,5

CREDENZA COMO SOPORTE MESA.
 CREDENZA SUPPORTING DESK.
 CRÉDENCE COMME MEUBLE PORTEUR.

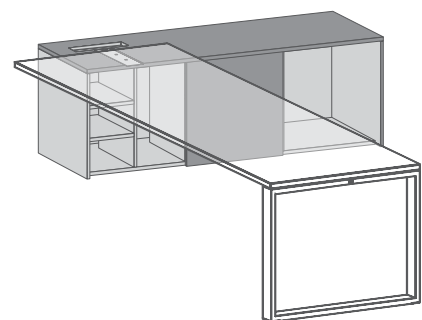

CM
 175 x 61 x 64

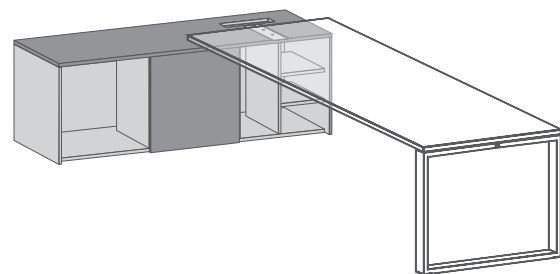

CM
 175 x 61 x 64

CAJONERA + ESTANTE PARA MÓDULO 1 DE LA CREDENZA.
 DRAWER UNIT + SHELF FOR MODULE 1 OF THE RETURN CREDENZA.
 CAISSON + ÉTAGÈRE POUR MODULE 1 DE LA CRÉDENCE.

CAJONERA + TAPETA PARA MÓDULO 1 DE LA CREDENZA.
 DRAWER UNIT + COVER FOR MODULE 1 OF THE RETURN CREDENZA.
 CAISSON + CACHE POUR MODULE 1 DE LA CRÉDENCE.

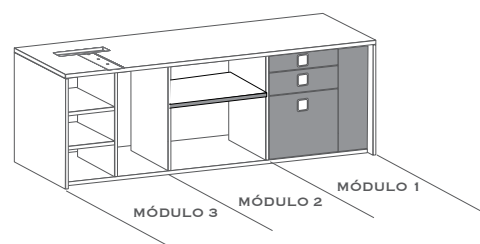
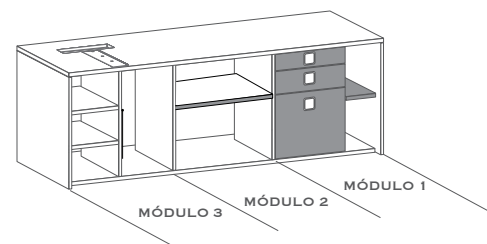

CAJONERA + POWER BOX PARA MÓDULO 1 DE LA CREDENZA.
 DRAWER UNIT + POWER BOX FOR MODULE 1 OF THE RETURN CREDENZA.
 CAISSON + POWER BOX POUR MODULE 1 DE LA CRÉDENCE.

CAJONERA + POWER BOX PARA MÓDULO 1 DE LA CREDENZA MUEBLE ALA.
 SHELF FOR MODULE 1 OF THE RETURN CREDENZA.
 ÉTAGÈRE POUR MODULE 1 DE LA CRÉDENCE RETOUR.

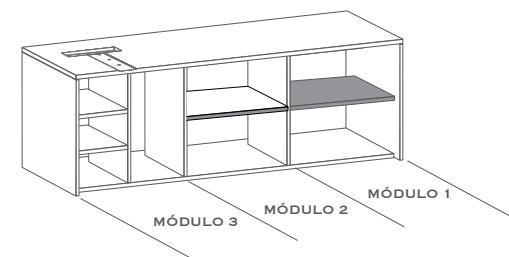
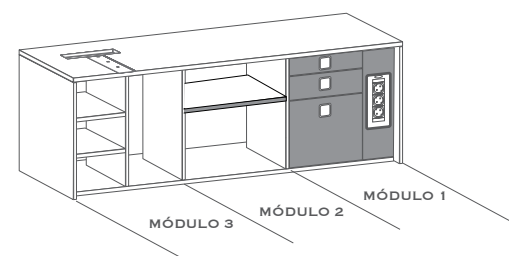

PUERTA ADICIONAL PARA MÓDULO 3.
 ADDITIONAL DOOR FOR MODULE 3.
 PORTE ADDITIONNELLE POUR MODULE 3.

PASACABLES ADICIONAL Ø8 CM.
 Ø8 CM CABLE GROMMET.
 OBTURATEUR Ø8 CM.

TIRADORES ADICIONALES.
 ADDITIONAL HANDLES.
 POIGNÉES ADDITIONNELLES.

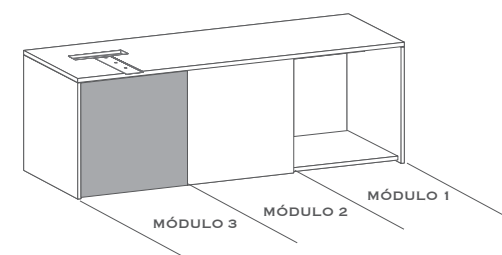

CM
 Ø8

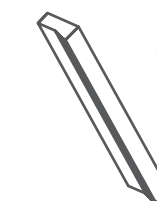

CM
 L20 x H2,0



CM
 L15 x H2,0

BLANCO / ALUMINIO / CROMADO.

CREDENZA.
 CREDENZA.
 CRÉDENCE.

ESTANTE PARA MÓDULO 2 DE LA CREDENZA.
 SHELF FOR MODULE 2 OF THE CREDENZA.
 ÉTAGÈRE POUR MODULE 2 DE LA CRÉDENCE.

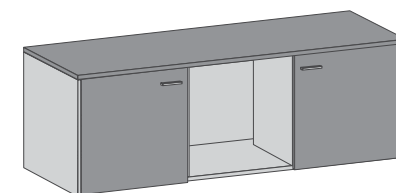

CM
 175 x 61 x 64

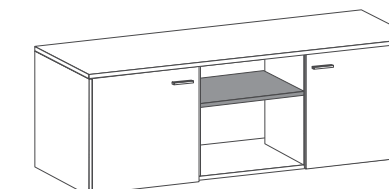

CAJONERA 4C PARA MÓDULO 2 DE LA CREDENZA.
 4 DRAWER UNIT FOR MODULE 2 OF THE CREDENZA.
 CAISSON 4T POUR MODULE 2 DE LA CRÉDENCE.

KIT 8 RUEDAS.
 KIT OF 8 CASTORS.
 KIT 8 ROULETTES.

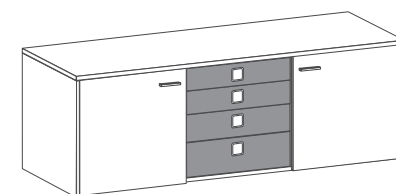

CM
 H=10